

Meter-Flo® Pumps

Direct-drive, smoothly operating pumps ideal for applications requiring continuous delivery of hydraulic or lube oils.

DESCRIPTION

Meterflo gear-type pumps are available in 11 models with displacements from 9 to 161 in³ (147 to 2,638 cm³) per minute at 1,140 rpm, and 14 to 245 in³ (229 to 4,015 cm³) per minute at 1,725 rpm. They are designed for pressures up to 1,500 psi (103 bar).

FEATURES/BENEFITS

- Positive displacement helps assure constant delivery of proper volume.
- Match-ground heat-treated steel gears are enclosed in a rigid, cast-iron housing to assure dependability and long life.
- Standard SAE 4-bolt mounting simplifies installation.
- Adjustable pressure relief valve protects pump against overload conditions. (See caution note, page 2)
- Meterflo pumps are available with a special coupling that allows easy replacement of older Meterflo pumps. (See ordering information for details).

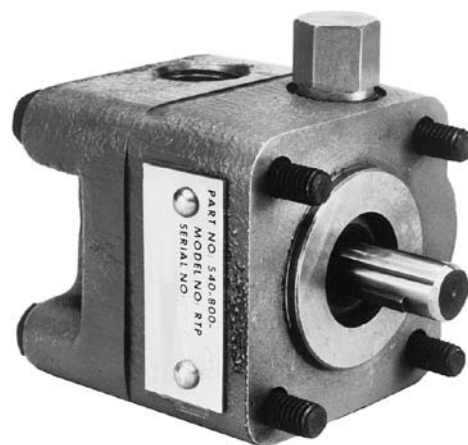

OPERATION

CROSS SECTION OF PUMP

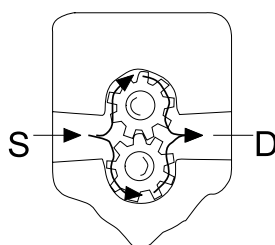
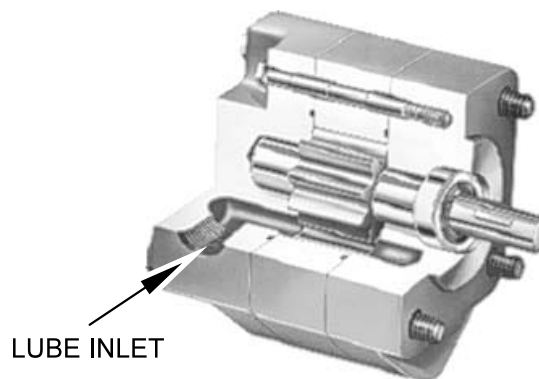

As the gears come out of mesh, oil is drawn into the suction side (S) of the pump, filling the spaces between the gear teeth. As the gears rotate, oil is carried between the teeth and the gear housing until it reaches the discharge port (D). As gears mesh, they force out the oil.

DIMENSIONS/Inches (mm)

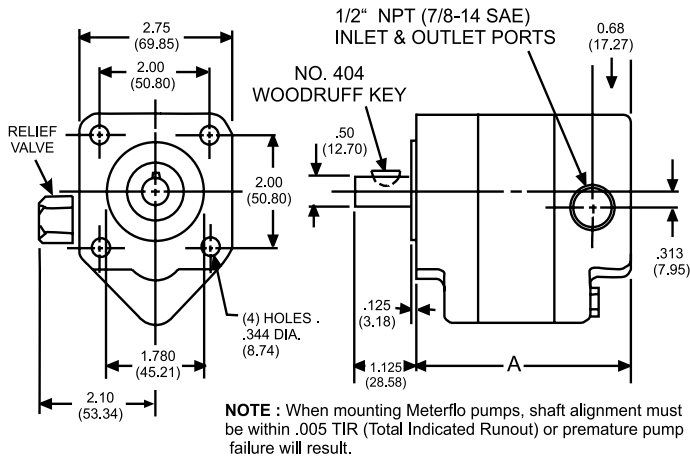

PART NO. (NPT PORTS)	OLD PART NO. (NPT PORTS)	PART NO. (SAE PORTS)	OLD PART NO. (SAE PORTS)	DISPLACEMENT in ³ (cm ³)/min.		DIM. A	
				1140 RPM	1725 RPM	in.	(mm)
557813	540-800-001 CCW	-	540-800-800	18 (295)	30 (492)	2.68	(68)
557814	540-800-011 CCW	558953	540-800-810	9 (147)	14 (229)	2.68	(68)
557815	540-800-021 CCW	-	540-800-820	56 (918)	84 (1,377)	3.00	(76)
558949	540-800-031 CW	-	-	56 (918)	84 (1,377)	3.00	(76)
557816	540-800-041 CCW	-	540-800-840	76 (1,245)	117 (1,917)	3.20	(81)
558950	540-800-051 CW	-	-	76 (1,245)	117 (1,917)	3.20	(81)
557817	540-800-061 CCW	-	540-800-860	111 (1,819)	168 (2,753)	2.68	(68)
558951	540-800-071 CW	-	-	111 (1,819)	168 (2,753)	2.68	(68)
557818	540-800-091 CCW	558954	540-800-890	26 (426)	40 (655)	2.75	(70)
557819	540-800-101 CW	-	-	9 (147)	14 (229)	2.68	(68)
557820	540-800-111 CCW	-	540-800-910	161 (2,638)	245 (4,015)	2.75	(70)
558955	540-800-940 CW	-	-	161 (2,638)	245 (4,015)	2.75	(70)

* Above displacements are nominal outputs at 600 psi (41 bar) using 350 SUS oil at 70°F (76 cSt @ 21°C).

NOTE: CW - Clock-wise rotation,
CCW - Counter Clock-wise rotation when facing pump shaft.

NOTE: OBSOLETE METER-FLO PUMPS: Systems with old Meter-Flo pumps (not listed above) can be converted with current pump models as follows: First, select the appropriate pump from the table above; then, order a special coupling assembly (Part No. 563303 (514-100-030)). This coupling permits the current pump to be used in existing systems, utilizing the same mounting brackets.

***ADJUSTING INTERNAL RELIEF VALVE:** Remove adjustment screw cap on inlet side of pump. Turn adjusting screw CW to increase relief pressure (1,500 psi max.) or, CCW to decrease relief pressure; replace cap.

*** CAUTION:** To avoid premature pump failure, this valve must be used only to relieve high pressure. **It must NOT be used in a continuous bypass situation.**

SPECIFICATION	
*Pressure (max)	Relief valve protected, 300-1500 psi (21-104 bar), Factory set @ 600 psi (41 bar)
Speed	1140 or 1725 rpm
Drive	Direct drive only
Seal	Buna-N
Recommended Operating Temp	
Min	50°F (10°C)
Max	150°F (65.5°C)
Porting	1/2 NPT or 7/8-14 SAE
Net Weight (approx)	5 to 6-1/2 lbs (2.26 to 2.95 kg)
Repair Kits	
Seal Kit	557997 (560-001-460)
Relief Valve Kit	557998 (560-001-920)

PUMP FLOW DATA/TEMP °F

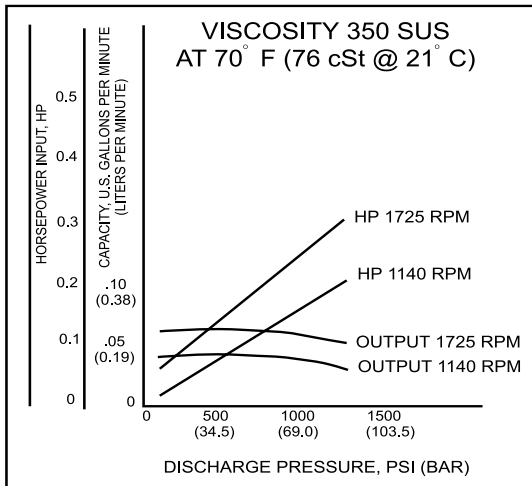

Note: The following output and horsepower tests were made using 1/2-inch tubing with a three-foot suction line. For information on oils with "SUS" lower than 350 (76 cSt) or higher than 2,900 (627 cSt), consult the factory

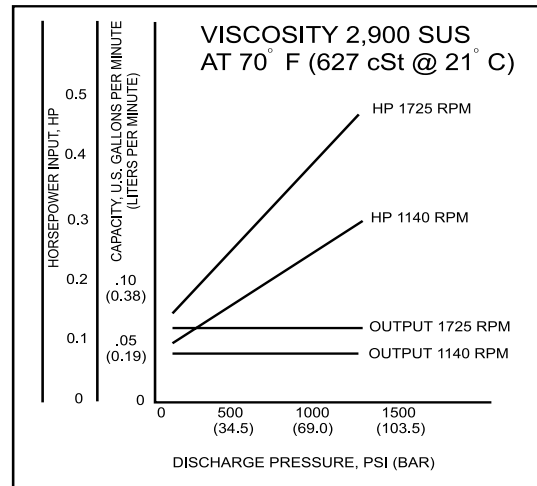

CHARTS ABOVE ARE FOR BOTH PUMP NUMBERS 557814 (540-800-011) (CCW) AND 557819 (540-800-101) (CW)

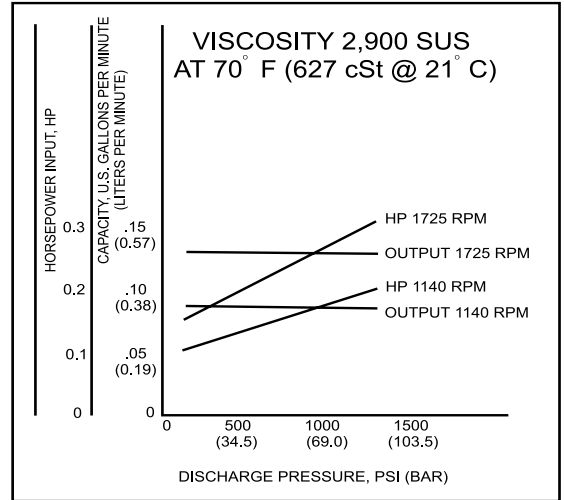
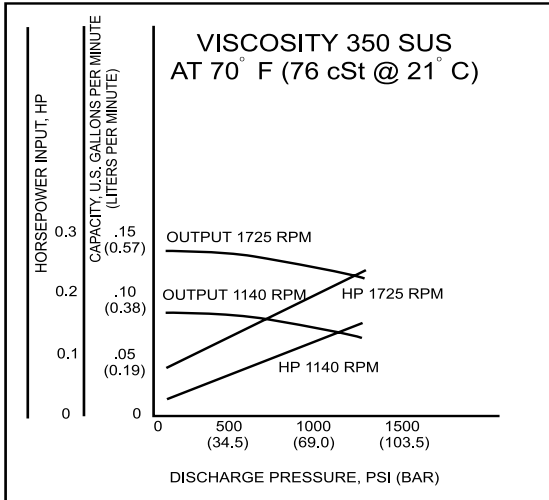

CHARTS ABOVE ARE FOR PUMP NUMBERS 557813 (540-800-001) (CCW)

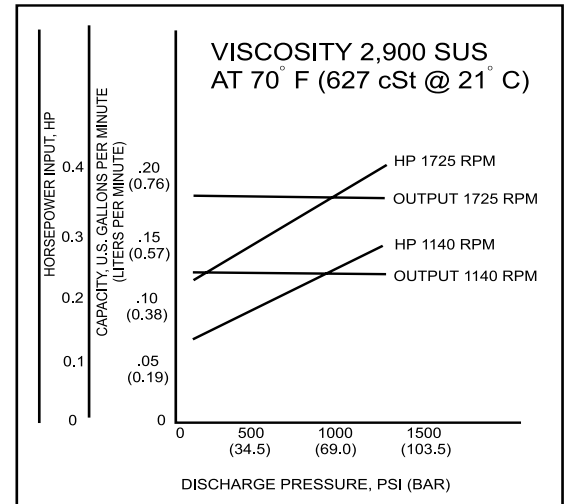
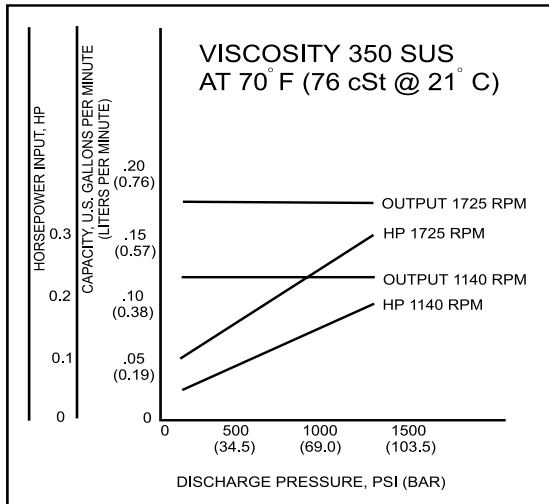

CHARTS ABOVE ARE FOR PUMP NUMBERS 557818 (540-800-091) (CCW)

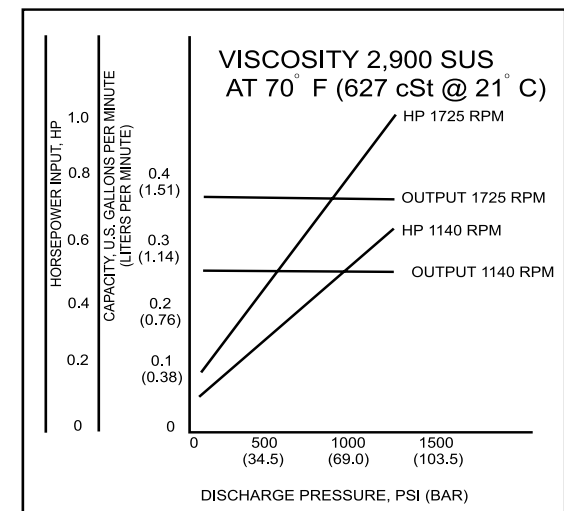
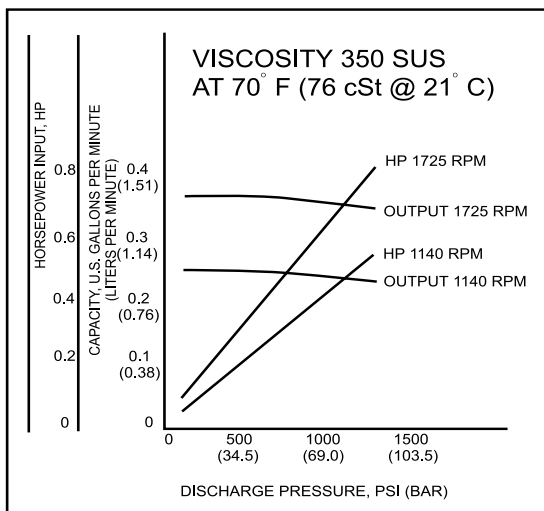

CHARTS ABOVE ARE FOR BOTH PUMP NUMBERS 557815 (540-800-021) (CCW) AND 558949 (540-800-031) (CW)

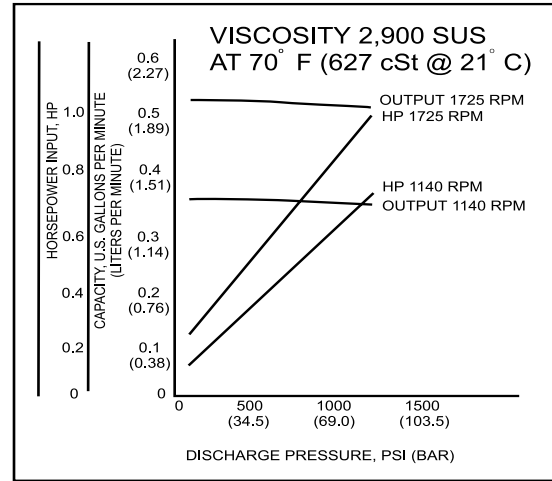
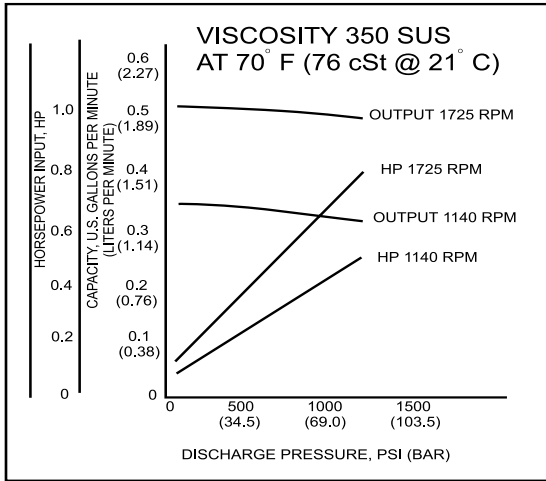

CHARTS ABOVE ARE FOR BOTH PUMP NUMBERS 557816 (540-800-041) (CCW) AND 558950 (540-800-051) (CW)

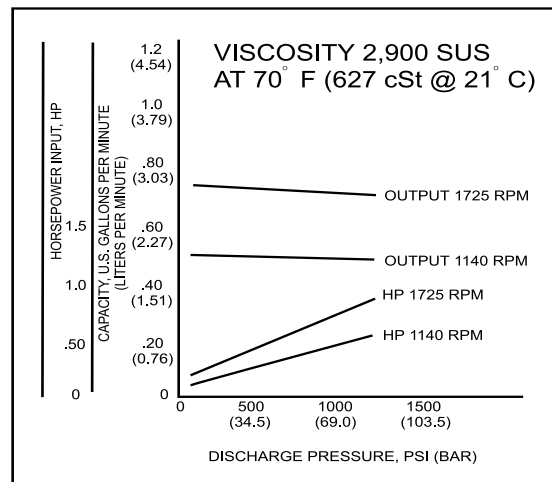
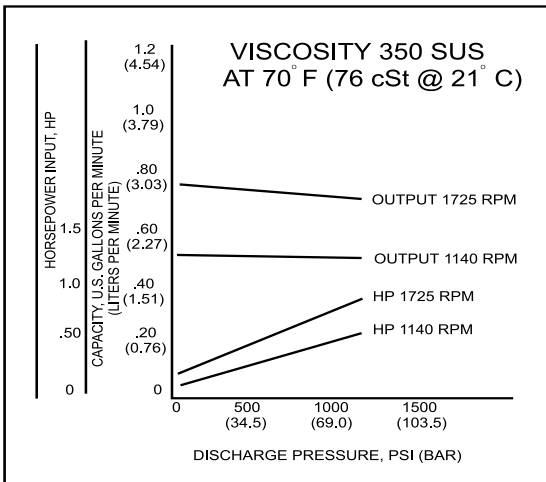

CHARTS ABOVE ARE FOR BOTH PUMP NUMBERS 557817 (540-800-061) (CCW) AND 558951 (540-800-071) (CW)

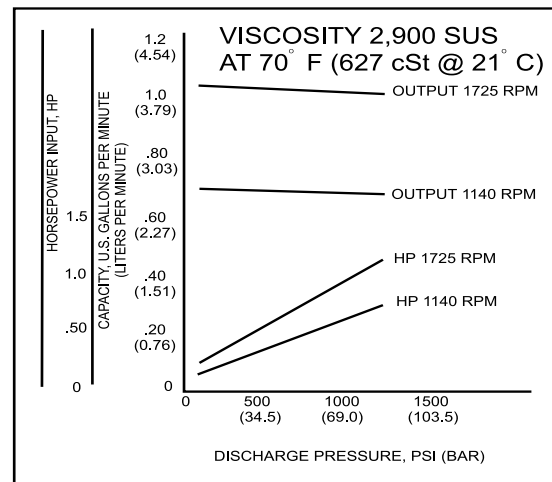
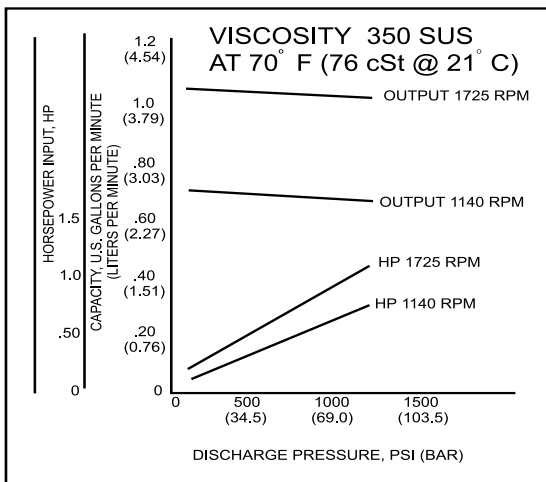

CHARTS ABOVE ARE FOR BOTH PUMP NUMBERS 557820 (540-800-111) (CCW) AND 558955 (540-800-940) (CW)

All written and visual data contained in this document are based on the latest product information available at the time of publication. Graco reserves the right to make changes at any time without notice.

Contact us today!

To receive product information or talk with a Graco representative, call 800-533-9655 or visit us online at www.graco.com.

